

**TURNIGY**<sup>®</sup>  
power systems

# 1/16 Scale 4WD Electric Powered Racing Buggy

## Instruction Manual

Item No. : A2003T



### **SAFETY PRECAUTIONS**

- THIS RADIO CONTROLLED RACING CAR IS NOT A TOY!
- THIS HIGH-PERFORMANCE R/C MODEL IS RECOMMENDED FOR AGES 14 AND OLDER.
- THIS IS ONLY FOR YOUR REFERENCE BEFORE YOU OPERATE THE MODEL CAR.
- FIRST-TIME BUILDERS SHOULD SEEK THE ADVICE OF EXPERIENCED MODELLERS BEFORE COMMENCING ASSEMBLY AND IF THEY DO NOT FULLY UNDERSTAND ANY PART OF THE CONSTRUCTION.
- ASSEMBLE THIS KIT ONLY IN PLACES OUT OF CHILDREN'S REACH!
- TAKE ENOUGH SAFETY PRECAUTIONS PRIOR TO OPERATING THIS MODEL. YOU ARE RESPONSIBLE FOR THIS MODEL'S ASSEMBLY AND SAFE OPERATION!

# BEFORE YOU RUN YOUR CAR

## Required equipment for operation

Tools required for building and maintenance:

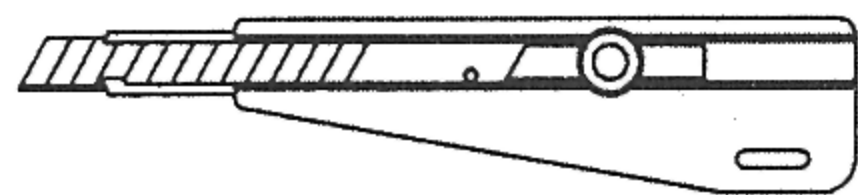

● Hobby knife

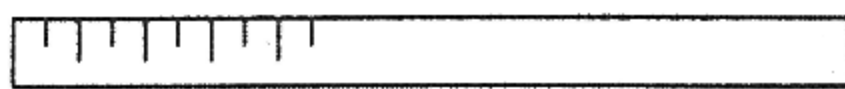

● Precision ruler or caliper

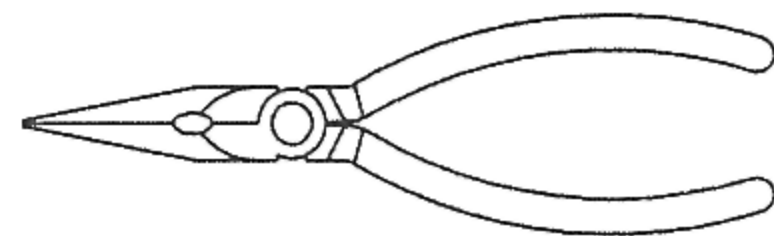

● Needle nose pliers

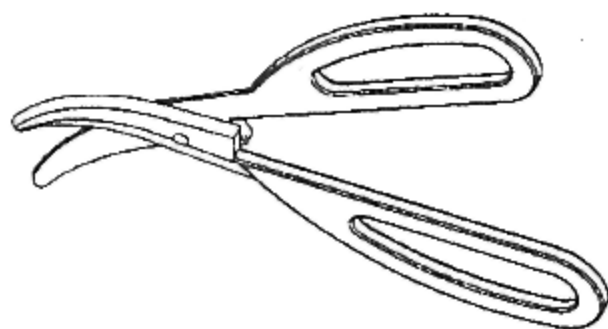

● Hobby scissors

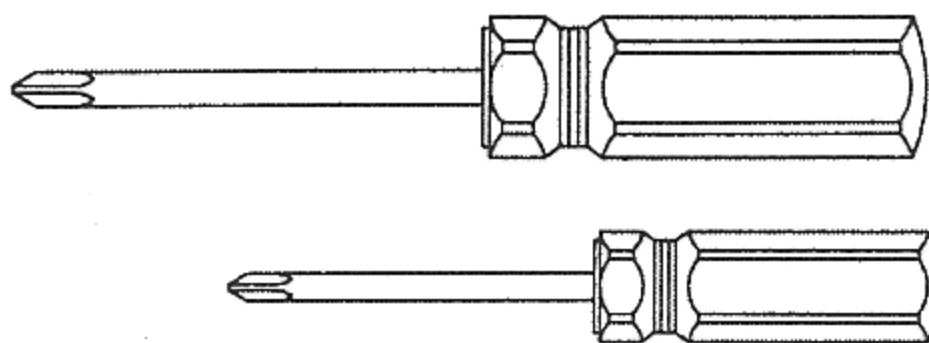

● Philips screwdriver



● Hex wrench

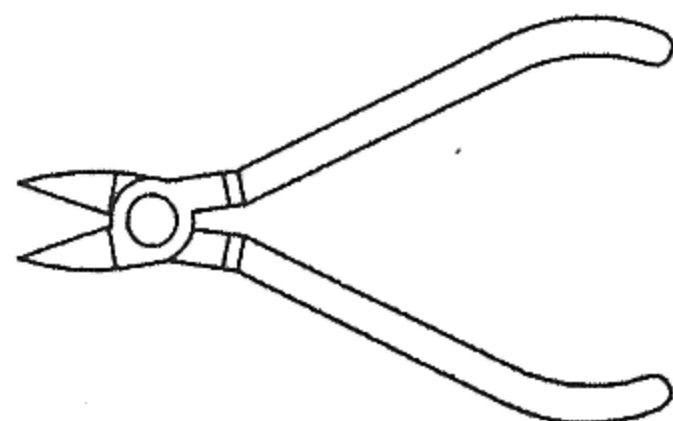

● Wire cutters

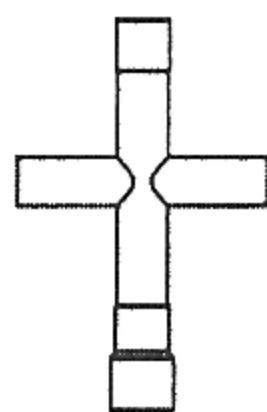

● Cross wrench

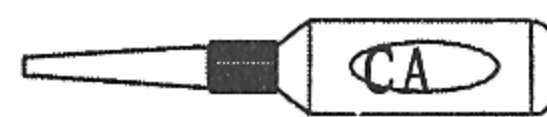

● CA glue & rubber cement

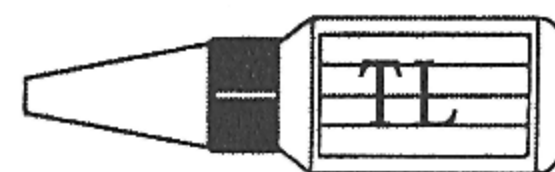

● Thread locking compound

### Important!!

Check all the screws are tight before using the car!  
Check all the screws are still tight after every battery pack used in the car!

### Recommended

Use thread lock on all screws that work loose.

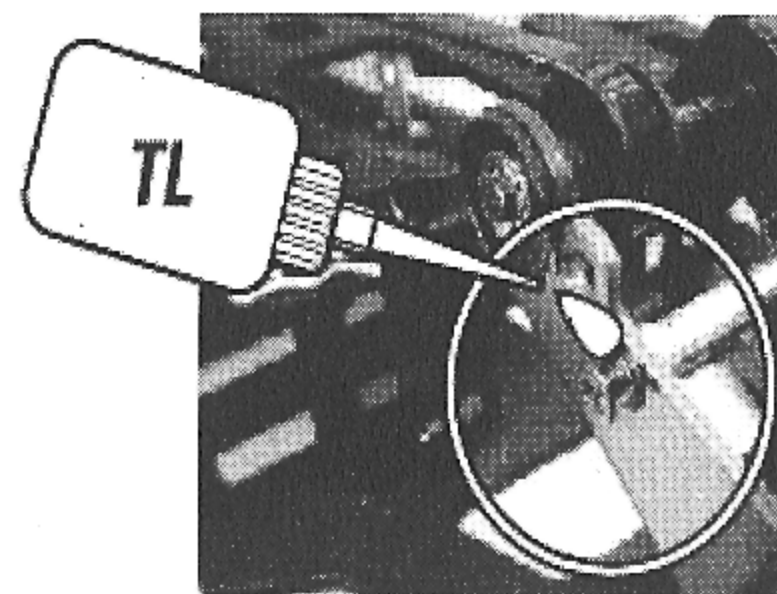

### PLEASE READ BEFORE STARTING!

Before you throw down this manual and unleash your new vehicle, please continue reading for just a few short minutes. In addition to important safety precautions, just below you will also find some quick tips for getting the maximum enjoyment out of your new vehicle. We would sincerely like to thank you for your purchase and hope that you enjoy the wonderful amount of fun and excitement that come from owning a high performance R/C vehicle. Whether you'll be hitting your local racetrack this coming weekend or just drag racing your buddies down the driveway, experienced racers and novices alike are sure to enjoy the performance and versatility of the vehicle 1/16 4WD buggy.

### SAFETY GUIDELINES

The vehicle is not intended for use by children without direct supervision of a responsible, knowledgeable adult. We shall not be liable for any loss or damages, whether direct, indirect, special, incidental or consequential, arising from the use, misuse, or abuse of this product and/or any product or accessory required to operate this product.

### IMPORTANT POINTS TO REMEMBER

Always, turn on your transmitter first before turning on your vehicle's receiver switch. When turning an R/C vehicle off, the order is just the opposite; Turn the receiver switch off first and then turn the transmitter off. Just remember that when your buggy is turned ON, your transmitter should always be turned ON. If not, A2003T will no longer be under the control of your transmitter, and could unexpectedly take off on its own, causing damage to itself and other people.

Never use old, worn out batteries in your transmitter or buggy. Use only fresh alkaline batteries or fully charged rechargeable batteries to ensure that you will not exceed the range of your radio system while driving your buggy. It is also very important to stop your buggy immediately when you begin to see that it is slowing down. This means the batteries in your buggy are close to being fully discharged, and if you continue to run your buggy after it has slowed, it may run "out of control" since it does not have sufficient voltage left to receive the signals from your transmitter.

Only run your A2003T in safe, open areas that will not put anything or anyone in danger of a collision. Use common sense when driving your buggy to ensure that you will not cause potential hazard to anyone (crowds of people and confined areas should be avoided). Although A2003T is small and lightweight, it can still hurt when it runs into you at ankle height. It can also startle someone who is not expecting it, so it is extremely important to ALWAYS keep a safe distance between any people and the path of your buggy (don't forget this includes yourself)!

Never run your A2003T through puddles, wet grass, snow or any other type of moisture. Also never use any liquid cleaners around the electronic components on your vehicle. Any small amount of moisture can cause several damage to your electronics.

If you will be running your A2003T with other R/C vehicles, always confirm before turning your transmitter on, that no one else is using your same frequency channel. If necessary, you may change frequencies (Certainly this is not related to 2.4G transmitter.)

Always let your motor and battery cool down completely between runs. The motor needs to cool completely at the end of charging before using again. Heat is a big enemy of electric motors. Over heating the motor will shorten its life and can cause it to fail. Prolonged running on high drag surfaces like grass, carpet etc. can heat the motor up and cause possible failure.

### **WHAT ELSE IS NEEDED:**

8 "AA" alkaline batteries (for the radio transmitter)

## **GETTING STARTED**

### **1. INSTALLING TRANSMITTER BATTERIES**

Install 8 new "AA" batteries into your vehicle transmitter. Check the life and proper installation of your batteries by switching the transmitter to on. On vehicle transmitters, you should see all three LED's light up (red, yellow, and green). If you do not, your batteries may be low on voltage or you may not have installed them all correctly. As the life of your transmitter batteries begins to decline, the green LED will no longer light. When you notice that you are down to only the yellow and red lights, this is a caution sign that it is time to install new batteries. If you continue operating your A2003T and see that the yellow light goes out (and only the red light is lit), STOP IMMEDIATELY! Your vehicle may easily travel out of range causing you to lose all control, which could result in a collision causing damage to the vehicle or other property.

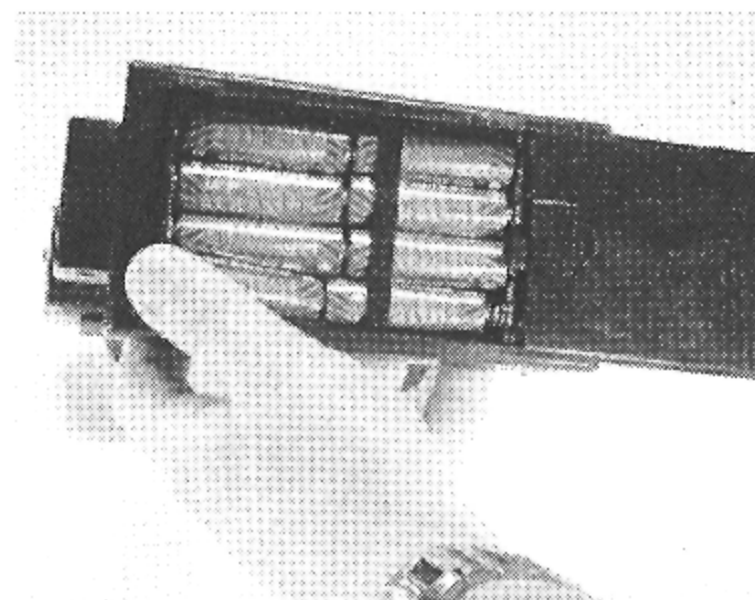

### **2. CHARGING YOUR VEHICLE**

Charge your A2003T battery pack. Connect the charger to your battery pack (it will only plug in one direction) and then plug the charger into a standard wall outlet. Charging takes approximately 3-4 hours. When the battery is charged unplug the charger and connect the battery to your speed control's battery plug. Your vehicle charger will safely charge your battery pack and not over charge it. Be careful when using after market chargers that you do not overcharge the battery pack and ruin it.

### **3. ASSEMBLING THE ANTENNA**

Locate the plastic antenna tube (found inside the manual bag).

Run the antenna wire up through the rear antenna mount hole in the upper chassis plate and begin feeding it into the plastic antenna tube until it comes



out the other side. Pull the remaining wire through the tube, and then press the tube into the antenna mount in the upper chassis plate. Bend the antenna wire down around the tube and install the black rubber antenna cap on the top of the tube. You may then wrap the remaining wire around the tube.



**DO NOT** cut the antenna wire off! This could shorten the range of your radio system.

## A Special Instructions About Batteries

### Contents:

1. Keep batteries/storage batteries out of reach of children.
2. Do not let batteries lie around openly, There is a risk of batteries being swallowed by children or pets. In such case, seek instant medical care!
3. Batteries/Rechargeable batteries must never be short-circuited, taken apart or thrown into fire. They might explode!
4. Leaking or damage batteries/rechargeable batteries might cause acid burns when getting into contact with skin. Therefore, use suitable protective gloves.
5. Conventional batteries must not be recharged. Danger of fire and explosion! Only charge rechargeable batteries which are intended for this purpose, use suitable rechargeable battery chargers.
6. Please observe correct polarity of batteries/rechargeable batteries and the connection of a re-chargeable battery pack(note plus/+ and minus/-) when inserting the batteries.
7. If the device is not used for a longer period of time (e. g storage), take out the inserted batteries/rechargeable batteries of the remote control to avoid damage from leaking batteries/rechargeable batteries. Recharge the rechargeable battery about every 3 months, because otherwise there may a so called deep discharge because of the self discharge, which makes the rechargeable batteries useless.
8. Always exchange the entire set of batteries or rechargeable batteries, Do not mix full batteries/rechargeable batteries with half-full ones. Always use batteries or rechargeable batteries of the same type and manufacturer.
9. Never mix batteries and storage batteries. Either use eight batteries or eight rechargeable batteries for the remote control/transmitter.

### Please Note:

Before the rechargeable battery pack delivery its maximum power, several complete dis-charge and charge cycles are necessary. Always drive the rechargeable battery pack empty, since recharging a "half - full" rechargeable battery pack can cause a so called memory effect. That means that the rechargeable battery pack loses its capacity, it no longer releases all of its saved energy, drive time is decreased. If you are using several rechargeable battery packs or rechargeable batteries, purchasing a high quality charger maybe worthwhile. They are normally also suitable for fast charging of rechargeable batteries.

### For this purpose, proceed as follows:

If the rechargeable battery pack was taken directly from the vehicle and is still hot, wait until the rechargeable battery pack has cooled down before you recharge.(min. of 5-10 minutes)  
Connect the plug-in charger with a proper mains socket.

Connect the rechargeable battery pack with correct polarity with the plug-in charger. Normally the special design of the two plugs avoids the incorrect connection of the rechargeable battery.

### Attention:

Do not use any force when plugging in it!

For reason of safety place the rechargeable battery pack on a non-flammable surface, eg. a tiled floor.

Keep the rechargeable battery pack away from flammable objects.

Never leave the rechargeable battery pack unattended.

The rechargeable battery pack gets warm during charging, this is normal.

Separate the rechargeable battery pack from the plug-in charger after charging, pull the plug-in charger from the mains socket.

Before using the rechargeable battery pack in the vehicle, wait until it has completely cooled down.

After your playing, please do not forget to cut the connections of battery and ESC!

### Disposal:

The user is legally obliged(battery regulation) to return used batteries and storage batteries.

Do not dispose of used batteries via the household rubbish!

Batteries/storage batteries containing harmful substances which been disposed via the household rubbish is prohibited.

You can return used batteries/accumulators free of charge to any collecting point in your local authority, so that you comply with your legal obligations and make your contribution to environmental protection.

## Special Instruction for ESC

### Basic functions & Features

1. The speed controller is fit for 1:16 model car use;
2. Input voltage: 2~3 cells LiPo battery or 5~9 cells Ni-MH, Ni-Cd battery
3. Continuous current: 25A, Peak: 85A
4. BEC output: 5V 1A
5. Automatically identify the throttle neutral position. When it had detected the neutral position, it would make 3 beeps, that means it can start.
6. Battery protection: In the course of running, if the voltage of each cell is lower than 3.0V, the ESC will cut off the output power.
7. Voltage cut off protection: If the voltage of the whole battery pack is lower than 4.6V or higher than 20V, the ESC can't be started and it will alarm, the alert tone will be emitted once per second.
8. Remote control signal lose protection: Motor drive immediately cut off when the signal transmission between transmitter and receiver is bad or instable; alert beep goes and strikes twice per second; normal run continues when the signal gets right,
9. Two-stage temperature protection: Cooling down through the power limit to achieve when the temperature reaches around 110°C, if the temperature continue to raise after power limit, motor will be intermittently turned off and the alert goes with 1 beep every two seconds. Now, you have to wait the temperature dropping back to normal and galvanize again to have the normal service.

When first using or changing remote controller, please execute the following steps to make the throttle range setting.

1. Switch on the transmitter, move the throttle stick to the end position of forward;
2. Switch on the ESC power, motor will make a "beep" sound;
3. 3 seconds later you will hear 1 beep again while the highest forward setting is recorded;
4. Move the throttle stick to the end position of backward;
5. After 2 seconds, there is a beep again while the highest backward throttle setting is recorded;
6. Move the throttle stick to the neutral position;
7. After 2 seconds, there are 3 beeps while neutral position is recorded and then it comes into the ready status.

### The LED Status in normal running

In normal use, if the throttle stick is in the neutral range, neither the red LED nor the green LED lights. Green light will flash when it goes forward and the red light when backward; red light is on all the while when it brakes; when various alert sounds go, the red light will be on.

### Trouble analysis and shooting:

1. After power on, if two beeps alert per second, it means the remote control signal been lost or the throttle is not in the neutral position; While if 1 beep, the input voltage may be out of the normal range.
2. The motor suddenly stops running while in working state and with alert tone, you can find out the cause through the frequency.
  - 1> if 2 beep strikes per second, it indicates the throttle signal is lost, please check the transmitter and receiver, or check the wire of the throttle channel, such as whether the crystal is loose or damaged.
  - 2> if there are 1 beep alert every two seconds, this indicates the ESC has entered the over temperature protection mode. Please check whether it is too hot.
  - 3> if the beep strike once per second, this indicates the ESC has entered the voltage protection mode, maybe the input voltage is too high or too low? Please check the voltage of battery pack.

### Fix:

Please refer to the following picture to fix ESC on car:

Battery negative (-) -----black power wire  
Battery positive (+) -----red power wire(Be careful the power connections, otherwise it will damage the ESC.)

Motor connection A----- black wire(black cover)

Motor connection B----- black wire(blue cover)

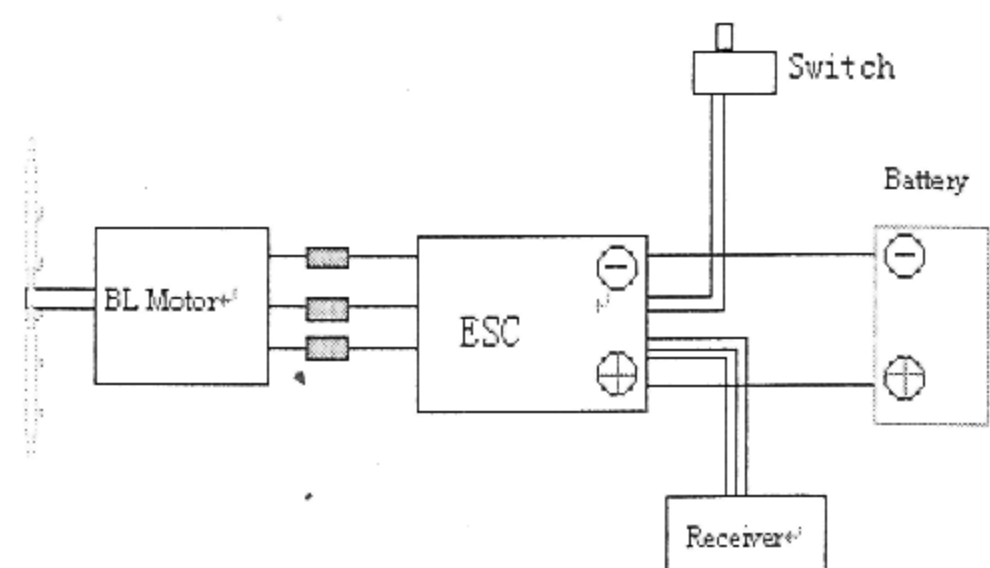

Motor connection C----- black wire (red cover)

changing any two motor connections, it can change the motor's run direction.

Receiver connected by three lines side by side.

GND-----black wire

5V battery power-----red wire

Signal-----white wire

## **Declaration for Using of Our Products**

Even if the vehicle is quite small at the first glance, there is risk of injuries in the case of crash with people(or animals), because of the high acceleration capacity and the high achievable speed.

Sharp edges and rotating parts also present a high danger!









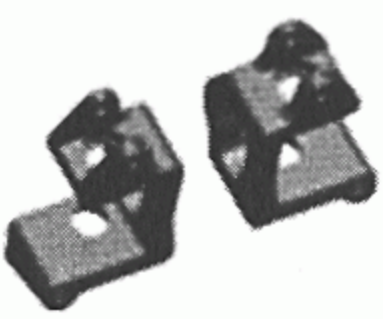
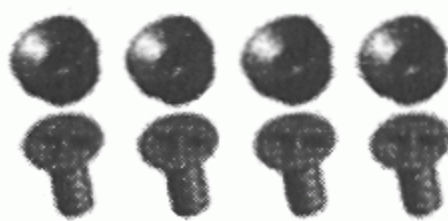

This is why you should drive very responsibly and carefully, this is especially the case for inexperienced drivers.

So, here we declared as below:

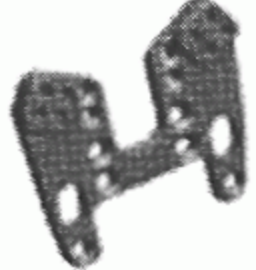
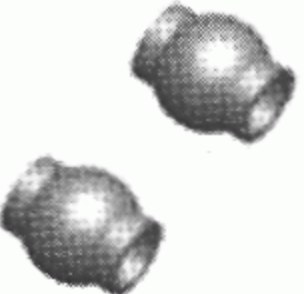
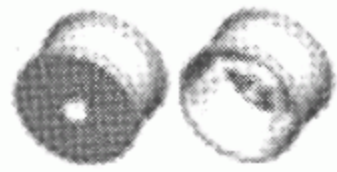
1. Please do note this manual carefully, especially the attentions parts and if you are a new player without enough experience, we will not take any responsibility for the car damages or injuries caused by incorrect operation!
2. Please do not change the matches of the ESC, motor and battery casually, if you want to make a change, please do ask for ideas of professional people, incorrect and unsuitable matches will effect the functions and the car's high performance, even it will cause the damages of the electronic parts and the crash of the car!  
We do not take the responsibility of car damages and injuries of unsuitable matches or equipment changes!
3. We have right to change the specification and parameter of the model and without notice in advance, please take the material object as the standard!

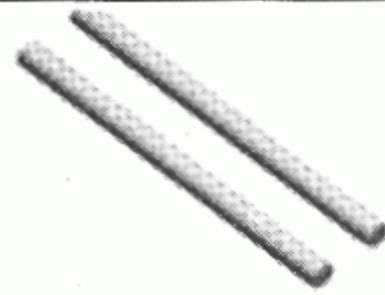

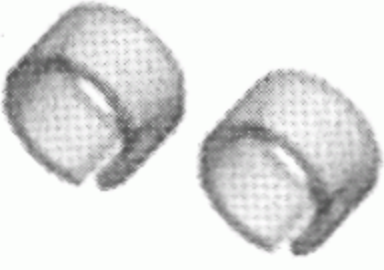
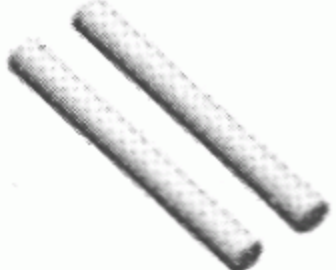



















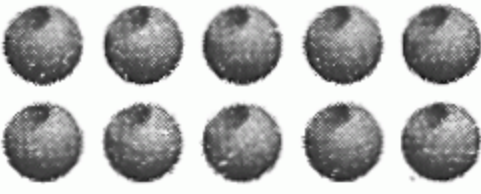





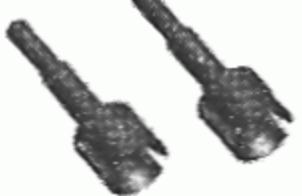

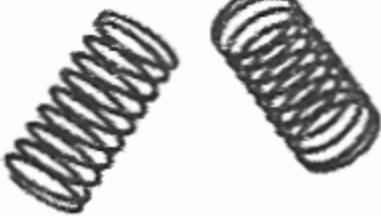









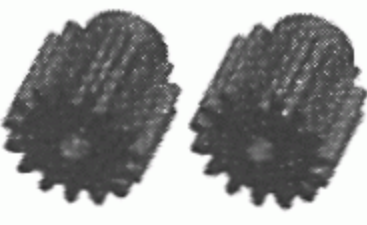

## SPARE PARTS FOR A2003T





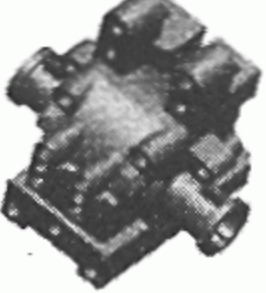















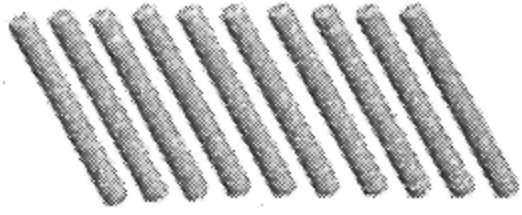

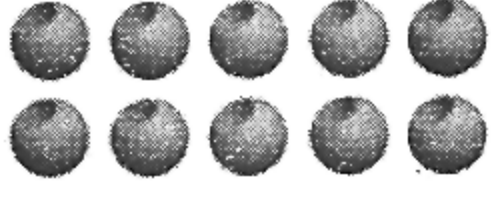
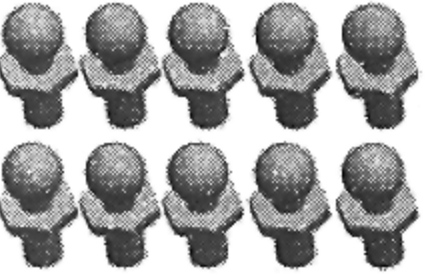

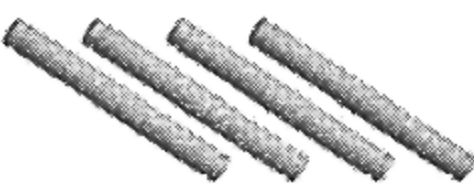



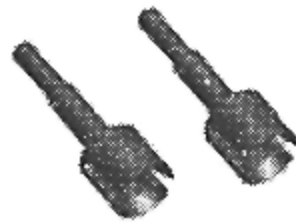
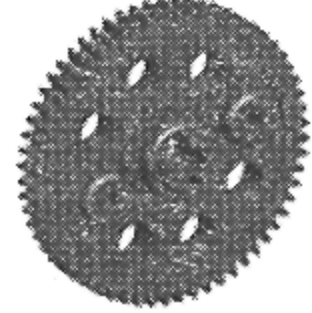

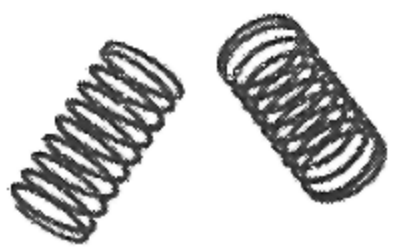

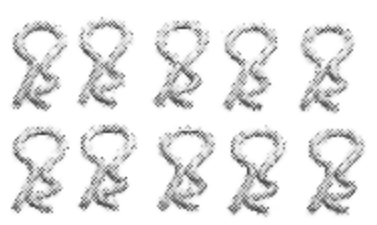





30028-Antenna pipe & cap 1set	30052-O-ring P3-10pcs	30083-M3 nylon nut 10pcs	30097-BT2.6*6 BH screw 10pcs	30184-Double-sided adhesive
				
30555- FH ISO2*10-10pcs	30709-rear bearing mount L/R	30719-Rear wing holder/mount complete	30731-front tyre	30740-sway bar ball end mount
				
30702-saver complete	30703-bumper	30705-bracket C L/R	30706-Bracket C Sleeve Spacer/ISO3*7 Screw	30708-Front steering arms L/R
				
30710-front upper sus.arms L/R	30711-front lower sus.arms L/R	30713-Front Upper Sus. Arm Sleeve Spacer	30714-Rear lower sus.arm mount	30716-Body mount F/R
				
30724-Sway Bar Back Plate ISO2*6	30725-wheel hub	30726-front shock tower	30727-rear shock tower	30730-front upper sus,arms ball end
				
30732-W-front wheel(white)-2pcs	30733-front tyre sponge-2pcs	30734-W-rear wheel(white)-2pcs	30736-front/rear gearbox housing	30737-rear tyre housing
				
30755-front lower sus.arm pinsφ	30776-ball bearing φ7*φ4*2.5	30785-M3*3 Screw	30797-BM3*10 Screw	30810-ball endM2*Sφ4
				
30741-steering linkage rod/ ball end mount3	30742-rear linkage rod /ball end mount 2	30748-rear tyre sponge	30753 Front Sway Bar /Sway Bar Collar/M3*3 Screw	30754-front sus.arm pins φ3*24.5mm
				
30756-rear sus.arm pins	30767-front lower sus.arms mount	30772-front upper sus.arms mount	30773-ball bearing φ8*φ4*3	30774-ball bearing φ6*φ10*3
				

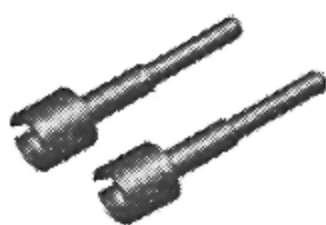
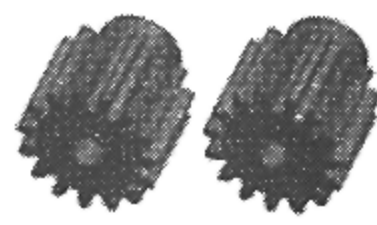



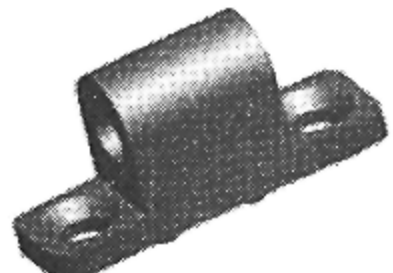

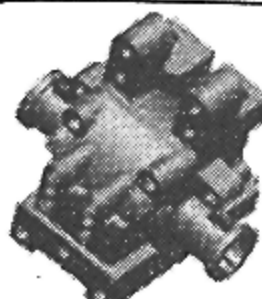





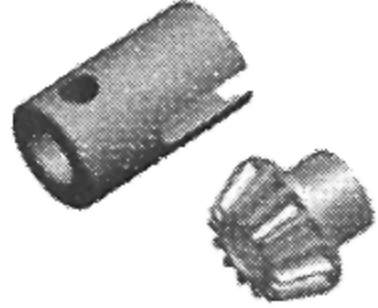

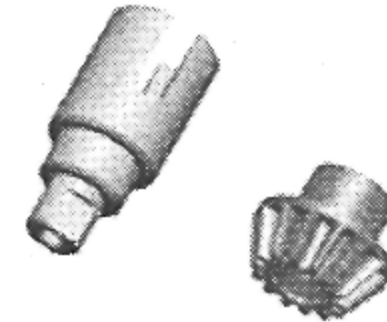

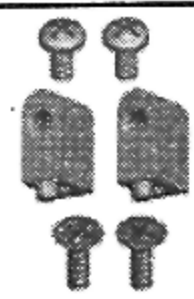

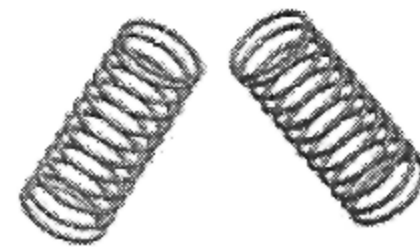

## SPARE PARTS FOR A2003T

B0028P-H- body	30779-2.3*0.4 E-clip 10pcs	30780-E-clip $\phi 3 \times 0.4 \text{mm}$	30781-Clip A 10pcs	30782-Steering Linkage/M3*6 Screw
				
30786-M3*8 Screw	30790-TPF2.6*6 Screw	30791-TPF2.6*8 Screw	30795-TPF2.6*16-10PCS	30796-BM3*12 Screw
				
30798-TPF2.6*10 Screw	30799-BT2.6*12 Screw	30804-pins $\phi 2 \times 18 \text{mm}$	30807-front/rear sus.arms plate-1pcs	30809-ball end $\phi 5.8$
				
30811-ball end M3*S $\phi$ 4.7	30813-Rear Sway Bar/Sway Bar Collar/M3*3	30816-Pin for Bracket C $\phi$ 3*25mm	30827-ISO3*6 Screw	30829-1front linkage rod/ball end mount1
				
30831-Rear lower sus.arms L/R	30864-Front Outdrive	30985-spur gear	32007-Diff. Pinion Gear B 2(long)/ Outdrive	32103-shaft for diff.bevel gear S $\phi$
				
30832-Pins $\phi 1.5 \times 7 \text{mm}$	30833-Clip D $\phi 1$	30834-ISO3*10 FH screw 10pcs	30835- screws BT3*6-10pcs	30839-screws BM3*17
				
30843-ISO2*6 Screw	30853-PWB screws PWB3*6-10pcs	30857-screws BT2.6*8- 10pcs	30862-front bogbone $\phi$ 2.5*45.0mm-2pcs	30863-rear dogbone $\phi$ 2.5*46.0mm-2pcs
				
30865-rear outdrive- 2pcs	30971-motor gear $\phi$ 2.3/15T	30980-upper plate	30982-BATTERY CLIP	30983-battery holder
				
30996-rear wing mount	30999- servo tie rod 1set	32003- rear gear box mount complete	32005-Diff. Pinion Gear B 1(short)/ Outdrive	32006-Diff. Pinion Gear S
				

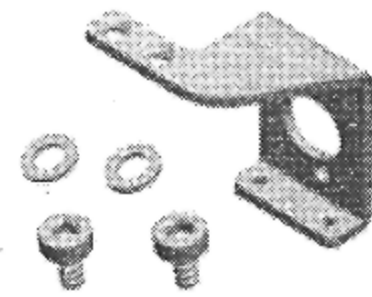
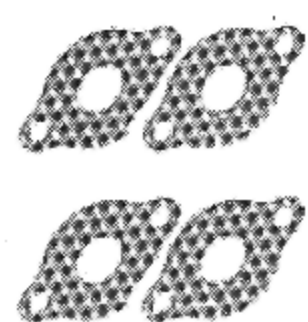
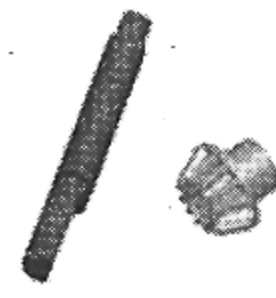
## SPARE PARTS FOR A2003T

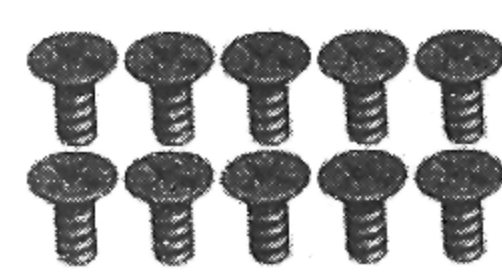
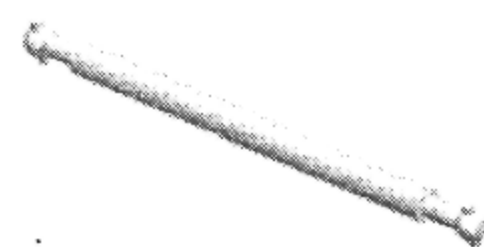
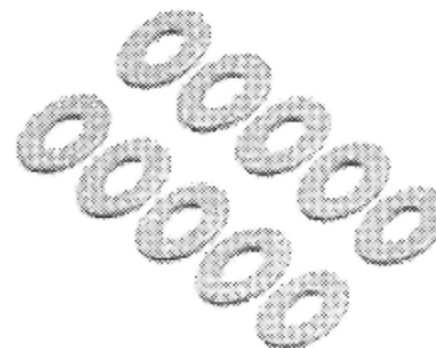
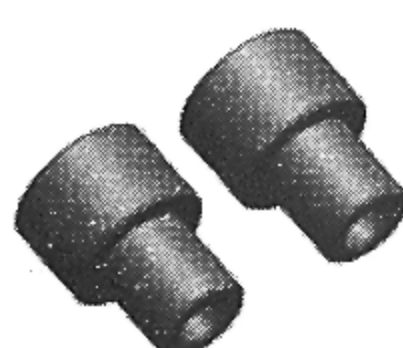
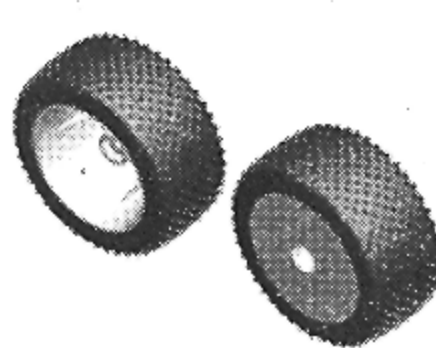
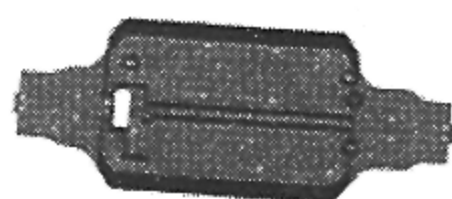

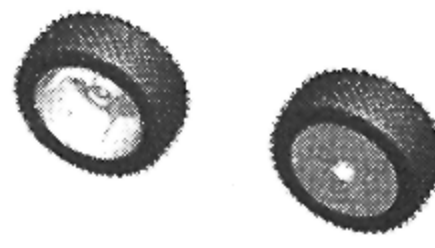
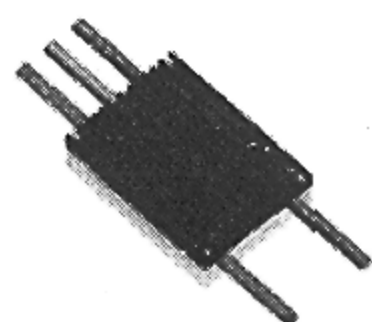
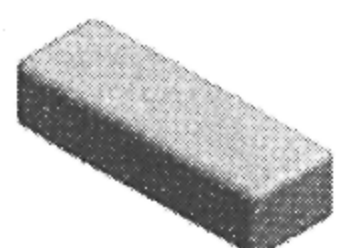







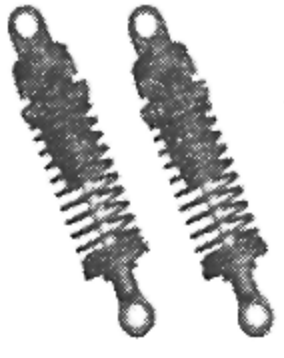



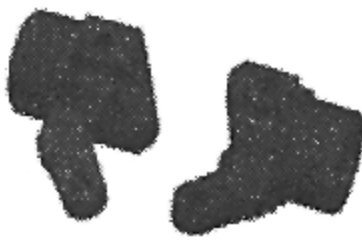

B0028P-H- body	30779-2.3*0.4 E-clip 10pcs	30780-E-clip $\phi 3 \times 0.4\text{mm}$	30781-Clip A 10pcs	30782-Steering Linkage/M3*6 Screw
				
30786-M3*8 Screw	30790-TPF2.6*6 Screw	30791-TPF2.6*8 Screw	30795-TPF2.6*16-10PCS	30796-BM3*12 Screw
				
30798-TPF2.6*10 Screw	30799-BT2.6*12 Screw	30804-pins $\phi 2 \times 18\text{mm}$	30807-front/rear sus.arms plate-1pcs	30809-ball end $\phi 5.8$
				
30811-ball end M3*Sp 4.7	30813-Rear Sway Bar/Sway Bar Collar/M3*3	30816-Pin for Bracket Cp 3*25mm	30827-ISO3*6 Screw	30829-1front linkage rod/ball end mount1
				
30831-Rear lower sus.arms L/R	30864-Front Outdrive	30985-spur gear	32007-Diff. Pinion Gear B 2(long)/ Outdrive	32103-shaft for diff.bevel gear Sp
				
30832-Pins $\phi 1.5 \times 7\text{mm}$	30833-Clip D $\phi 1$	30834-ISO3*10 FH screw 10pcs	30835- screws BT3*6-10pcs	30839-screws BM3*17
				
30843-ISO2*6 Screw	30853-PWB screws PWB3*6-10pcs	30857-screws BT2.6*8- 10pcs	30862-front bogbone $\phi$ 2.5*45.0mm-2pcs	30863-rear dogbone $\phi$ 2.5*46.0mm-2pcs
				
30865-rear outdrive- 2pcs	30971-motor gear $\phi$ 2.3/15T	30980-upper plate	30982-BATTERY CLIP	30983-battery holder
				
30996-rear wing mount	30999- servo tie rod 1set	32003- rear gear box mount complete	32005-Diff. Pinion Gear B 1(short)/ Outdrive	32006-Diff. Pinion Gear S
				

## SPARE PARTS FOR A2003T

32008-Drive Gear/Univ. Joint	32009-driven gear	32013-shaft for diff.bevel gear S	32014-drive gear w/outdrive	32101-front upper/lower sus.srm holder
				
32338-pinion shaft holder	32348-servo holder	33176-battery post with TPF2.6*8(black)	33319-manual	32317-crush sleeves photon $\phi 5.7*\phi 4.0*1.1$
				
32104-rear shock springs $\phi$	32156-front plastic shock complete	32157-rear plastic shock complete	32308-sliper 1 set	32347-rear gear box complete
				
32339-motor mount	32342-slipper gasket	32343-mental drive grive gear with shaft	32345-socket screw M2.5*10L	33037-ISO2*12-10pcs
				
32349-ISO2.5*6 screw	32362-drive shaft	32726-shack washer-1pcs	32802-shock sleeve spacer-2pcs	33200-rear tyre, wheel, sponge -2pcs
				
33177-A2010 plastic chassics 1pcs	33178-washer $\phi 2.7*\phi 5*0.5$	33179-socket screw M2.5*5	33199-front wheel, tyre,sponge-2pcs	B1058(25A)-brushless ESC
				
B1080-lipo battery 7.4V-1300mAH	B1122-brushless motor (B2040(KV4800))			
				

Recommend: B1080 --- 7.4v1300mAh Lipo Battery

## Upgraded Spare Parts

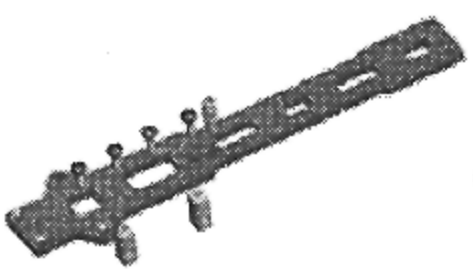
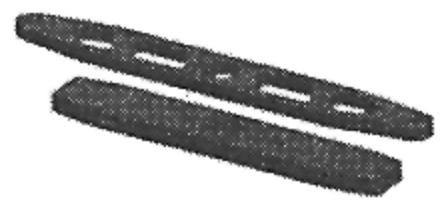
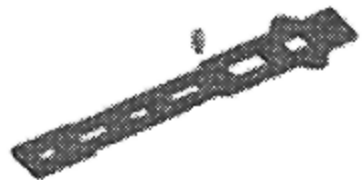
30900-Front Alum. Shocks-blue color-	30901-Rear Alum. Shocks-blue color	30902-Servo saver complete-blue- 1set	30903-Lower sus. Arm bracket f/r- blue	30905-Front uprights 1/r-blue- 1set
				
30906-Front shock tower-blue- 1pcs	30907-Rear shock tower -blue-1pcs	30908-Front knuckle arms l/r-blue- 1set	30909-Rear hubcarrier l/r-blue-	30910-Front upper sus. Arms l/r-blue-
				
30911-Front lower sus. Arms l/r-blue-	30912-Rear lower susp. Arm-blue- 2pcs	30913-Front CVD 2pcs	30914-Rear CVD 2pcs	30918-Swaybar backplate-blue- 4pcs
				
30940-Front shock tower-1pcs (carbonfiber ) BM3*20.5-2pcs M3 screw-2pcs	30941-Rear shock tower-1pcs (carbonfiber ) BM3*20.5-2pcs M3 screw-2pcs	30942-Upper plate-1pcs (carbon fiber ) Antenna support-1pcs servo support 1pcs BM3*6 screw-4pcs	30943-battery holder -1pcs (carbon fiber ) cushion-1pcs	32304-Upper plate-1pcs(glassfiber ) Antenna support-1pcs
				
32306-battery holder -1pcs (glassfiber ) cushion -1pcs	33192-chassis-1pcs(glassfiber )	33324-spur gear-1pcs(POM )		
